

TWO DIFFERENT CHOICES

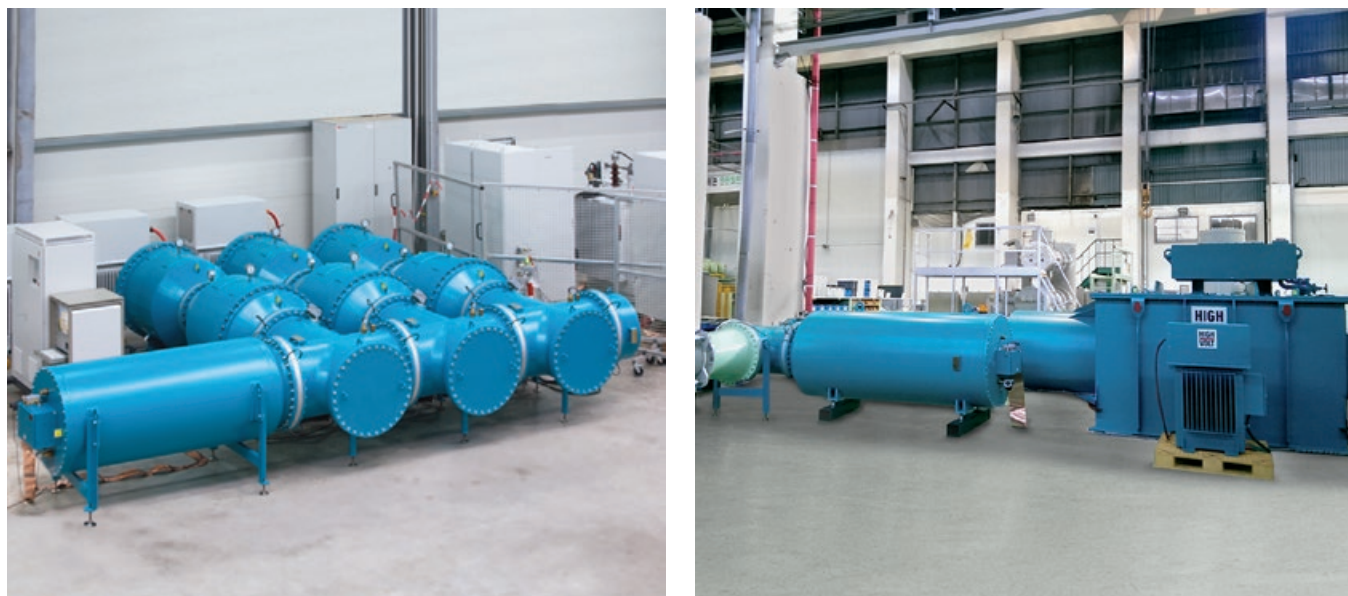

Fig. 10 AC test system WRVG 5.7/750 G (gas-insulated reactors, left side) and WRV 6/750 G (oil-insulated reactor, right side)

GIS/GIL TESTING WITH RESONANT TEST SYSTEMS

APPLICATION

HVAC variable frequency resonant test systems are mainly used for:

- Factory testing of large complete GIS
- Factory testing of components for GIS, such as insulators, electrodes, etc.
- Factory testing of voltage and current transformers for use with GIS, especially if higher frequencies are needed to prevent core saturation
- Test of accessories, e.g. SF₆ to air or SF₆ to oil bushings
- Research, development and education

Depending on the required duty cycles either a system with an oil (WRV G) or SF₆ insulated (WRVG G) reactor can be offered. PD measurements and diagnosis are conveniently possible with both of the systems.

BENEFITS

- DIRECTLY FLANGED TO TEST OBJECT, FULLY SHIELDED
- PD NOISE LEVEL < 2 PC
- PURE SINUSOIDAL WAVEFORM
- COMPACT DESIGN
- FREQUENCY RANGE 45 TO 65 HZ

FACTS IN BRIEF

The AC resonant test systems with variable frequency, types WRVG G and WRV G are an alternative to the transformer based systems. They are flanged directly to the test object so that test system and test object are completely encapsulated for a space saving test setup. Safety clearances between test system or test object and walls or ceiling are not necessary due to the grounded GIS housing.

The main component of the system is an HV reactor which can be SF₆-insulated (system WRVG G) for short test cycles, or oil insulated (system WRV G) for longer test cycles or more tests per day.

The test frequency of resonant systems is determined by the inductance of the test system and the capacitance of test object and test system. By selecting appropriate inductance and capacitance of the test system the test frequency can be maintained within the range of 45 to 65 Hz required by IEC standards. Higher frequencies are possible for instrument transformer testing.

- HIGH POWER, LARGE LOADS
- EASY AND FAST TEST SETUP
- LOW LOSSES, LOW NOISE EMISSION
- MAINTENANCE-FREE

AC TEST SYSTEMS FOR GIS/GIL

WHICH SYSTEM FOR WHAT TEST?

The following table contains our recommendation of systems for each application.

Operating principle	Transformer based		Variable frequency resonance	
	SF ₆ gas	Oil	SF ₆ gas	Oil
Insulating medium				
Test case	Type WPG G	Type WP G	Type WRVG G	Type WRV G
Large complete GIS	power too small	✓	✓✓	✓✓
Small complete GIS	✓	✓✓	✓✓	✓✓
GIS components (few per day, e.g. type testing)	✓✓	✓	✓✓	✓
GIS components (production routine tests, many per day)	duty cycle too short	✓✓	duty cycle too short	✓✓
Rain and pollution tests on SF ₆ to air bushings	✓✓	✓✓	losses in test object too high	
Inductive voltage transformer tests ¹⁾	depending on VT design		✓✓	✓✓
Current and capacitive voltage transformer test	✓✓	✓✓	✓✓	✓✓
Instrument transformer calibration at rated frequency	✓✓	✓✓	frequency not fixed	
PD measurement and diagnostics	possible	possible	possible	possible

1) Tests of inductive voltage transformers may require higher test frequencies to prevent saturation of the VT core

- ✓ test possible with this system
- ✓✓ test system ideally recommended for this test

For further information please contact: **HIGHVOLT Prüftechnik Dresden GmbH**
Marie-Curie-Straße 10
01139 Dresden
Germany

Phone +49 351 8425-700
E-mail sales@highvolt.com
Web www.highvolt.com

**HIGH
VOLT**
Test with the best.®

AC TEST SYSTEMS FOR GIS/GIL



Fig. 1 AC test system WPG 500/750 G (gas-insulated transformer, left side) and WP 1000/500 G (oil-insulated transformer, right side)

GIS/GIL TESTING WITH TRANSFORMER BASED TEST SYSTEMS

APPLICATION

HVAC transformer based GIS test systems are mainly used for:

- Factory testing of small complete GIS, such as spacers, electrodes, instrument transformers, disconnectors, circuit breakers, and small complete GIS systems
- Factory testing of voltage with GIS (the test system can be provided with a power supply for higher frequencies)
- Test of accessories, e.g. SF₆ to air or SF₆ to oil bushings
- Research, development and education

The test systems can be used as voltage source for PD measurement. They are directly flanged to the test object, so that test system and test object are fully encapsulated. This allows a space saving test setup without safety clearances between test system or test object and walls or ceiling.

BENEFITS

- DIRECTLY FLANGED TO TEST OBJECT, FULLY SHIELDED
- PD NOISE LEVEL < 2 PC
- PURE SINUSOIDAL WAVEFORM
- COMPACT DESIGN
- RATED FREQUENCY 50 OR 60 HZ

FACTS IN BRIEF

The transformer based test systems operate exactly at power frequency, so that the type of voltage applied for testing and operation is exactly the same. Two different versions are offered:

- Systems type WPG G with SF₆-insulated high voltage transformer for load capacitances up to 2...4 nF (depending on test voltage level) and duty cycles up to approx. 1 hour per day (more than any competitor)
- Systems type WP G with oil-insulated high voltage transformer for higher loads or longer duty cycles

The systems type WPG G are a new development designed for superior load capacitance and duty cycle compared to other similar systems. Extensive type testing simulating >10 years of heavy duty operation including frequent breakdowns with very fast transient overvoltages (VFTO) has been conducted to ensure reliable long-term operation.

- DESIGNED FOR LONGER DUTY CYCLES
- EASY AND FAST TEST SETUP
- LOW LOSSES, LOW NOISE EMISSION
- MAINTENANCE-FREE

AC TEST SYSTEMS FOR FACTORY TESTING OF GIS/GIL

- AC withstand test
- PD diagnostics
- For complete GIS, GIS components, bushings, instrument transformers, etc.

1.70/5 WPG...G + WRV(G)...G

TRANSFORMER BASED TEST SYSTEMS FOR GIS/GIL

TECHNICAL DETAILS

For transformer based test systems the test frequency is independent of the test capacitance. It is determined by the power supply frequency, so normally 50 or 60 Hz will be used, unless a frequency converter provides another frequency. The oil-insulated test systems are mainly designed for a continuous duty cycle, which makes them especially suitable for routine testing integrated in GIS component production processes.

The SF₆-insulated transformers have been developed as a light-weight alternative to the oil insulated systems. They are especially designed for an extended load range and a longer duty cycle compared to other similar types. Further they are equipped with a winding temperature monitoring system. In contrast to fixed duty cycles (e.g. 15 minutes ON per day) this system allows to start a new test as soon as the winding temperature has fallen low enough, thus allowing more tests per day for better system utilization.

EXAMPLES: PARAMETERS AND LOAD DIAGRAMS

Table 1 Standard transformer based test systems

Test system	Rated voltage [kV]	Rated current [A]	Max. capacitance at rated voltage, 50 Hz [nF]	Duty cycle at rated current
with SF ₆ -insulated transformer				
WPG 250/510 G	510	0.49	2.9	Flexible ¹
WPG 500/750 G	750	0.67	2.6	Flexible ¹
WPG 800/1050 G	1050	0.76	2.0	Flexible ¹
with oil-insulated transformer				
WP 800/400 G	400	2	15.6	1 h ON – 1 h OFF; 3 x per day
WP 1000/500 G	500	2	12.7	1 h ON – 1 h OFF; 3 x per day
WP 1200/600 G	600	2	10.6	1 h ON – 1 h OFF; 3 x per day
WP 2000/800 G	800	2.5	10.9	1 h ON – 1 h OFF; 3 x per day
WP 2000/1000 G	1000	2	10.6	1 h ON – 1 h OFF; 6 x per day

¹ A fixed duty cycle is always calculated for the worst case. On-line monitoring allows more tests, as soon as the temperature is low enough. Minimum 3x15 minutes ON per day at rated power, 40 °C/104 °F ambient and 25 °C/77 °F daily mean temperatures guaranteed.

Examples of operating ranges

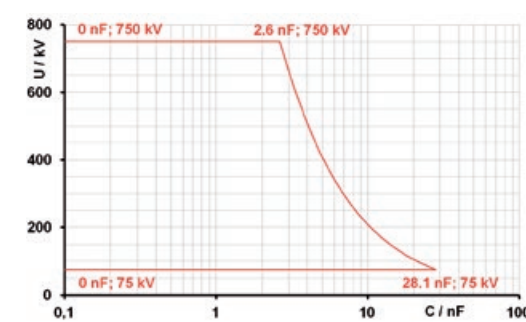

Fig. 2 WPG 500/750 G (example)

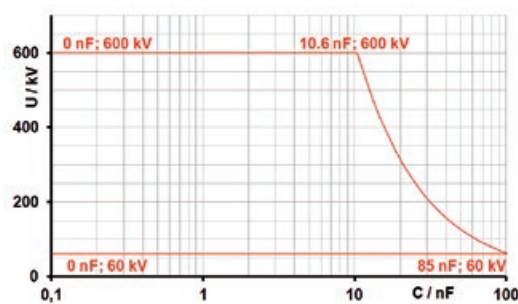

Fig. 3 WP 1200/600 G (example)

BENEFITS

SF₆-INSULATED TEST SYSTEM WPG G

- LARGER TESTABLE CAPACITANCE
- MORE TESTS PER DAY: ONLINE MONITORING OF TEMPERATURE → EARLIER START OF NEXT TEST → OPTIMUM UTILIZATION OF SYSTEM
- INTEGRATED VOLTAGE DIVIDER

SUITABLE FOR ON-SITE USE

- RATED VOLTAGES ADAPTED TO TYPICAL TEST VOLTAGE LEVELS
- RELIABLE LONG TERM OPERATION PROVEN BY TYPE TEST SIMULATING > 10 YEARS OF HEAVY DUTY OPERATION, INCLUDING FREQUENT TEST OBJECT BREAKDOWNS

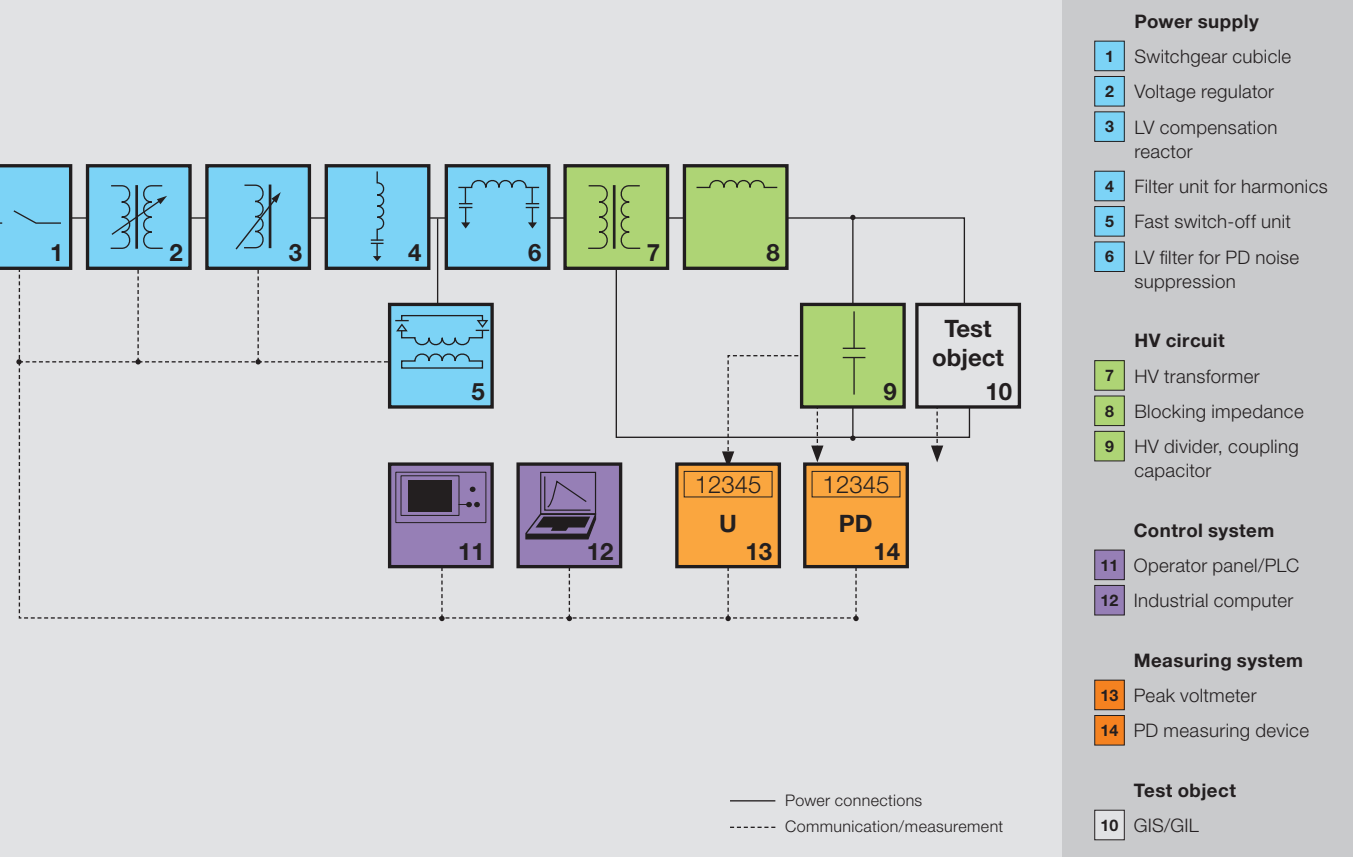

Fig. 4 Block diagram of AC testing of GIS with transformer based test systems

SYSTEM AND COMPONENTS

The HV transformer (see fig. 4, item 7) is fed via the switchgear cubicle (1) and the voltage regulating transformer (2). To reduce the mainly capacitive load currents of the test object, compensating reactors on the low voltage side (3) can be applied. Several filter and protection elements can be arranged on the low voltage side to guarantee the sinusoidal voltage shape, filters for harmonics (4) are used. If the system is intended to be used for PD measurement the application of a low-pass filter (6) for suppressing noise signals from the mains is useful. In the case of breakdown of the test object the energy flow and the transient overvoltages in the circuit can be limited by the fast switch-off unit (5).

The components of the high voltage circuit are all completely encapsulated for compactness, to avoid the necessity of safety clearances as well as the coupling of PD noise signals. The voltage divider (9) and the peak voltmeter (13) serve for voltage measurement. A blocking impedance (8) can be applied for further reducing electrical noise signals, when partial discharges are measured at the test object. In this case the voltage divider or another capacitor can be used as coupling capacitor. The control and measuring system HiCOS includes the operator device (11) and/or an industrial PC (12) as well as the peak voltmeter (13) and PD measuring instrument (14). Optical connections (Profibus or Ethernet) are used between these components as well as to the programmable logic controllers (PLC) in the switchgear cubicle (1). The integrated control software iCOS allows automated test procedures, automated measurement and analysis, storage of all measurement data in a data base as well as automated test protocol generation. It allows interaction with other HIGHVOLT test and measuring systems in the test field as well as a combination of their measured data.

OIL-INSULATED TEST SYSTEM WP G

- CONTINUOUS DUTY CYCLE – BEST SUITED FOR CONTINUOUS PRODUCTION TESTING
- HIGHEST POWER RATINGS
- OVERLOAD RESERVES

VARIABLE FREQUENCY RESONANT TEST SYSTEMS FOR GIS/GIL

TECHNICAL DETAILS

Standard test systems type WRVG G with SF₆-insulated reactors are available up to 750 kV and 5.7 A. At rated parameters these test systems have a duty cycle up to 15 min ON per day at rated power [see table 2], which can be extended for smaller test loads. Each reactor provides up to 1.9 A, for higher currents several reactors can be switched in parallel. Test systems type WRVG G with oil-insulated reactors allow a maximum test voltage of up to 750 kV as well. The duty cycle is much longer due to the excellent cooling capabilities of insulating oil, see table below.

The test frequency depends on the involved capacitances. Typically these are those of test object, voltage divider and coupling capacitor, if included in the system. The frequency shall be maintained between 45 and 65 Hz for GIS tests in the factory according to IEC 60694, 62271-203 and 60060-3. If, due to a low capacitance of the test object, the frequency becomes too high an additional capacitance can be connected in parallel. However it is also possible to test at frequencies between 100 Hz and 200 Hz necessary for voltage transformer tests.

EXAMPLES: PARAMETERS AND LOAD DIAGRAMS

Table 2 Standard variable frequency resonant test systems

Test system	Rated voltage [kV]	Rated current [A]	Max. capacitance at rated voltage [nF]	Duty cycle at rated current
with SF ₆ -insulated reactor				
WRVG 1.5/460 G	460	1.5	7.7	15 min ON per day
WRVG 1.5/680 G	680	1.5	3.5	15 min ON per day
WRVG 1.9/750 G	750	1.9	8.9	17 min ON per day
WRVG 5.7/750 G	750	5.7	23.7	17 min ON per day
with oil-insulated reactor				
WRV 2/500 G	500	2	12.7	1 h ON – 1 h OFF; 3 x per day
WRV 11/500 G	500	10.8	42.9	1 h ON – 1 h OFF; 1 x per day
WRV 6/750 G	750	6	25.5	1 h ON – 1 h OFF; 4 x per day

Test frequency depending on total load capacitance

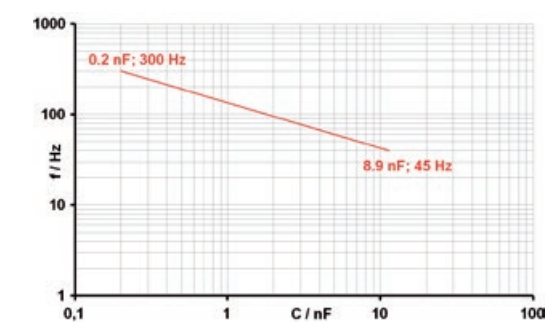

Fig. 5 of WRVG 1.9/750 G (example)

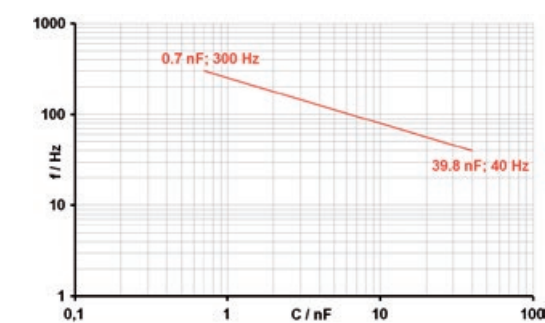

Fig. 7 of WRV 6/750 G (example)

Operating range of test reactor

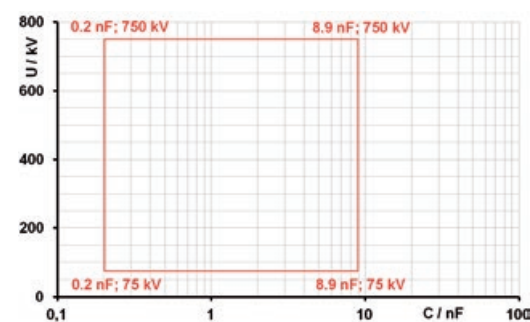

Fig. 6 of WRVG 1.9/750 G (example)

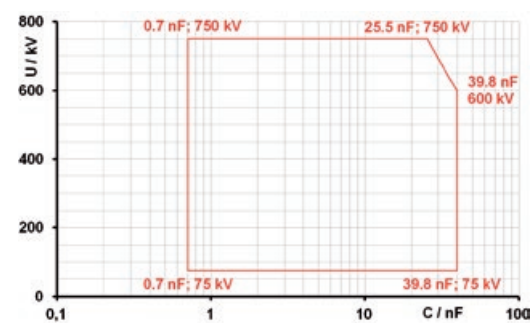

Fig. 8 of WRV 6/750 G (example)

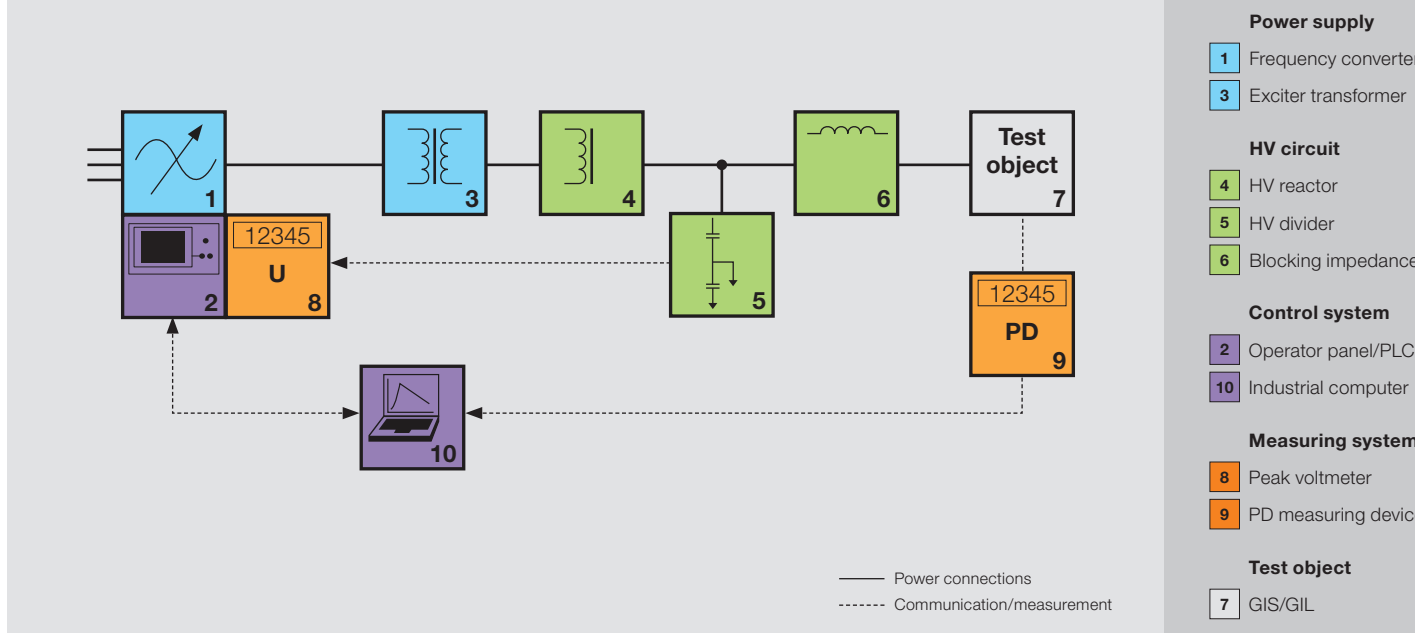

Fig. 9 Block diagram of AC testing of GIS with variable frequency resonant test systems

TECHNICAL DETAILS

By use of the variable frequency resonance principle very compact test systems with few components are possible:

The system consists mainly of the control and feeding unit, which contains a static frequency converter (see fig. 9, item 1) and the HiCOS basic control system (2). The frequency converter converts the three-phase input voltage into a single-phase output voltage with a rectangular waveform. The control system also integrates the peak voltmeter for voltage measurement.

The frequency is automatically tuned exactly to the resonant frequency of the HV series resonant circuit formed by the resonant reactor (4) and the GIS/GIL to be tested. The test voltage is regulated by the inverter output voltage and measured by a calibrated measuring system consisting of the peak voltmeter in the control system (8) and a voltage measuring divider (5).

BENEFITS

SF₆-INSULATED SYSTEM WRVG G

- ULTRA COMPACT DESIGN
- LIGHT WEIGHT
- EASY HANDLING AND LIFTING FOR FLANGING TO COMPLETE GIS POSSIBLE

OIL-INSULATED SYSTEM WRV G

- DESIGNED FOR HIGH LOADS
- LONG DUTY CYCLES
- COMPACT DESIGN